

SPECTRA

Individuality through modularity

COFFEE ENJOYMENT
IN COUNTLESS
COMBINATIONS







The Franke Spectra is a master of flexibility. The coffee machine adapts to your needs – and not vice-versa. Three basic models, three control panels, various options and add-on units provide maximum coffee enjoyment in many combinations. Assemble your own personal Spectra and play with the many enticing options.



SPECTRA S UNIQUELY MODULAR

How much coffee variety do you need? Whatever your requirements might be, the Spectra has the right solution for you. Select your personal coffee machine from three basic models and countless combinations.

The Spectra S is the heart and soul of coffee making. It offers the whole range of coffee and milk specialities. It is individually expandable and capable of handling up to three different coffee varieties as well as fresh milk, powdered milk and chocolate powder.

- 1 INDIVIDUAL OPERATION
- 2 OPTIMAL HANDLING
- 3 TASTEFUL OPTIONS
- 4 SIMPLE CLEANING

4



INDIVIDUAL OPERATION

The choice is yours: Basic, Vetro 8 or Vetro 16. Different application areas ask for different operating concepts. Spectra takes this into account by offering a selection of different control panels. With the Vetro 8, for example, the customer sees the range of Coffee specialties offered at a glance.



**TOUCH+GO
CONTROL**



OPTIMAL HANDLING

The outlet automatically adjusts to the height of the cup and returns to its home position right after. The variable adjustment range (70 to 180 mm) enables the use of all standard-size cups and glasses. The dispenser can be easily removed and safely cleaned in a dishwasher.



TASTEFUL OPTIONS

Your beverage ideas know no limits. Add the chocolate powder dosing unit to the Spectra S and surprise your customers with an aromatic coffee selection and individual milk foam creations.



**TWIST+TASTE
TECHNOLOGY**



SIMPLE CLEANING

Hygiene and maintenance at the highest level: The new Clean+Clever System ensures easy and immaculate cleaning of the device in the least possible time. The Clean+Clever System in the CF2 milk system automatically adds water during cleaning and reduces cleaning effort.



**CLEAN+CLEVER
SYSTEM**

FRANKE MILK+FOAM SYSTEM FOR EXCELLENT TASTE

Where there's coffee, there's milk. And where milk is an ingredient, hygiene is essential. Whether made with fresh milk or milk powder, coffee-milk specialities are easy to prepare. Offer your customers the greatest possible coffee enjoyment.

SPECTRA S WITH AUTOSTEAM PRO

Would you like to automate beverage preparation while still being able to manually foam milk? The 2-Step approach is the complete solution without an integrated milk system. The first step is to prepare the coffee beverage. In the second step, the milk is foamed using the Autosteam Pro steam wand. Finally, the desired beverage is mixed in the classical way by hand.



Spectra S with Autosteam Pro

Autosteam Pro for milk foam enjoyment

With Autosteam Pro, you can heat or foam milk at the touch of a button. Milk, air and steam are automatically mixed to create a perfect milk foam. The temperature and air supply can be individually programmed for each product.

Milk foam at the touch of a button

The freely programmable buttons can be used for Autosteam Pro. Whether preparing Cappuccino or Latte Art – you obtain precisely the milk foam quality you need. And thanks to the temperature sensor, it will always be at the right temperature.

Personalized enjoyment

With the 2-Step approach, you can readily offer different milk types. Even soy milk can be foamed at the touch of a button.

Clean and safe

The high-quality materials of the steam wand prevent milk from drying on the wand and avoid burn hazards while guaranteeing maximum hygiene and safety standards and easy daily cleaning.

Latte Art

A feast for the eyes. Thanks to the 2-Step milk system with Autosteam Pro, you can prepare coffee and milk fully automatically while still being able to combine them artfully. Pamper your guests with personal creations.



**MILK+FOAM
SYSTEM**

SPECTRA S

WITH THE INTELLIGENT MILK SYSTEM

The milk dispensing head is integrated in the combination dispenser of the coffee machine. As a result, coffee and milk can be dispensed simultaneously. You have the choice: milk is either delivered before, during or after the coffee is dispensed. The integrated pump precisely doses cold and hot milk in a process that is electronically controlled and defined by the coffee machine programming. The certified rinse and cleaning program for the coffee and milk section simplifies the maintenance and care of the machine. It ensures hygienic milk processing at all times. The entire fresh milk system is rinsed automatically at regular intervals – the frequency is defined by you. The combination outlet can be easily removed and cleaned.

The compressor refrigeration unit can hold up to twelve liters of milk, or if two types of milk are used, five liters of milk each. The milk system is available as a customized solution with a flexible milk connection to undercounter equipment.



Spectra S Twin with milk system in the Black Line Version

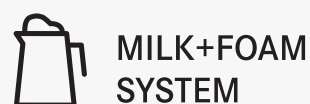

**MILK+FOAM
SYSTEM**

Spectra S with milk system and cup warmer.



SPECTRA X

A NEW DIMENSION OF BREWED COFFEE

With a width of only 30 cm, the Spectra X offers everything that you would expect from a high-output brewer – and more.

- 1 HIGHEST QUALITY
- 2 GROUND COFFEE OR THE WHOLE BEAN
- 3 DIFFERENT BREWING STAGES
- 4 DRY DISCHARGE
- 5 AUTOMATIC CLEANING PROGRAM



HIGHEST QUALITY

Perfect processing and careful storage of the coffee are essential for preparing excellent brewed coffee. Ground coffee is conveyed directly to the brewing chamber through the dosing unit. The ground powder is brewed in an almost pressure-free process. The brewed coffee stays absolutely fresh in a closed, flavor-neutral glass container.



GROUND COFFEE OR THE WHOLE BEAN

You have the choice of preparing coffee using ground coffee (ground coffee dosing unit for 2 kg) or the whole bean (grinder for 1.2 kg).



DIFFERENT BREWING STAGES

The Spectra X uses four brewing stages. Thus, you can always prepare exactly as much coffee as you need in the course of a day. The glass container holds two liters and is individually filled in four brewing stages (0.4 to 2 liters). The dispensing quantities are freely programmable – for a cup, mug, and small or large jugs. The optional special outlet for jugs has a dispensing height of 25 cm.

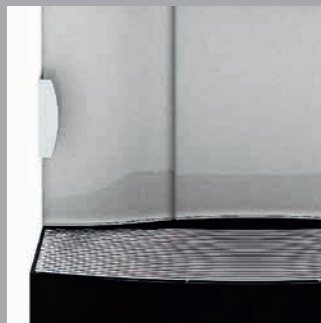

DRY DISCHARGE

Thanks to a new brewing method, coffee grounds are absolutely dry when discharged into the grounds container. The system is operated in the same manner as a specialities machine.



AUTOMATIC CLEANING PROGRAM

Simple and efficient. Instead of using cleaning fluids, the Spectra X is cleaned with a single tablet. The Clean+Clever System ensures absolutely hygienic conditions in the brewing chamber and glass container.





SPECTRA X-XL

POWERFUL AND FLEXIBLE

The Spectra X-XL is a compact and powerful fully automatic coffeemaker designed for preparing large volumes of brewed coffee. Ideal for the breakfast buffet or as a self-service station in catering facilities or rest stops. A perfect fit for all locations requiring high volumes paired with superior quality-expectations.

- 1 HIGHEST QUALITY
- 2 DIFFERENT BREWING STAGES
- 3 SIMPLE CLEANING
- 4 JUG DISPENSER

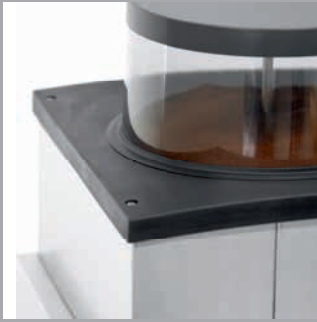

HIGHEST QUALITY

- Perfect processing and careful storage of the coffee are essential for preparing excellent brewed coffee. Ground coffee is conveyed directly to the brewing vessel through the dosing unit. The ground powder is brewed in a pressure-free process and without filter paper. The brewed coffee stays absolutely fresh in a closed, flavor-neutral glass container.
- High output requirements ask for high storage capabilities. A cumulated 8 liters split between the 4 litre brewing chamber and the 4 litre coffee reservoir can be dispensed at peak times.
- The 3 kg coffee ground holding capacity of the ground chamber, equipped with fill level control guarantees an optimal, aroma conserving storage of the coffee at all times.



DIFFERENT BREWING STAGES

The Spectra X-XL uses four brewing stages. Thus, you can always prepare exactly as much coffee as you need in the course of a day. The glass container holds four liters and is individually filled in four brewing stages (1, 2, 3 or 4 liters). The dispensing quantities are freely programmable – for a cups, mugs, and small or large jugs.



SIMPLE CLEANING

The fully automated Clean+Clever System ensures absolutely hygienic conditions in the brewing chamber, glass container as well as the outlet itself.



**CLEAN+CLEVER
SYSTEM**



JUG DISPENSER

Equip your Spectra X-XL with the optional Thermos Tray and matching dispensing arm for jugs and flasks with up to 265 mm height. A welcomed add-on for breakfast, seminars and when catering to larger groups.

BASIC CONTROL PANEL

THE CHOICE IS YOURS: BASIC, VETRO OR VETRO 16

Different applications ask for different operating concepts. We accommodate various needs by offering a selection of three control panels. Whether by keypad or glass panel, you, your guests and the Spectra will always communicate perfectly.



TOUCH+GO
CONTROL

FRAME LIGHTING

You can also adapt your operator panel to match the appearance of its surroundings. You have your choice of colors for the frame lighting.

PROVEN SIMPLICITY

The Basic operator panel includes ten buttons that can be labeled as desired. With the Shift function, you can expand your product range to up to 18 products. The display provides all of the information you need on beverages dispensed, operating sequences and machine status.



VETRO 8 CONTROL PANEL

NEVER HAS SELF-SERVICE BEEN EASIER OR QUICKER



Customers instantly recognize the product they want from the image and text, press the picture and obtain the product. The Vetro 8 control panel accommodates up to eight images. Together with the outlet's automatic height adjustment, the Vetro option is perfect for modern self-service.

VETRO 16 CONTROL PANEL

AN EVEN GREATER SELECTION



The Vetro 16 control panel has space for up to 16 products. The color design of the buttons can be adjusted to your wish. With the clever preselection system and the corresponding machine configuration, you can use the buttons to prepare up to 48 different coffee beverages, coffee-milk beverages, or mixed beverages of milk, coffee and/or chocolate.



OUR 5 STRATEGIC AREAS OF PRODUCT DEVELOPMENT

Our focus in product development is innovative system solutions. We concentrate on coffee machines that unify functionality, simple handling and efficiency. The Franke Coffee Systems feature icons visually highlight our commitment to applying our expertise in the interest of our customers' success.



TOUCH+GO CONTROL

Franke Touch+Go Control stands for the control panel that makes our coffee machines simple and intuitive to operate. We value self-explanatory procedures in products that are used on a daily basis. It is our goal to minimize the number of operating steps while meeting the growing demand for diverse product options at the same time.



MILK+FOAM SYSTEM

The Franke Milk+Foam System lets you experience the art of fully automatic milk preparation. It is used wherever perfectly prepared milk variations are of the essence. The selection of different milk variations and milk foam consistencies for each individual product creates beverage configurations that lead to entirely new recipes.



TWIST+TASTE TECHNOLOGY

Thanks to the Twist+Taste technology, the diversity of beverage variations is almost limitless. It arises from the perfect interaction of the chocolate powder and/or syrup options with the Milk+Foam systems. With these systems, the development of new recipes knows no bounds.



CLEAN+CLEVER SYSTEM

The Clean+Clever System is based on an intelligent cleaning concept that ensures compliance with stringent hygienic standards. The user-friendly operating steps of our innovative cleaning processes range from the use of materials that require little cleaning to automation that eases and simplifies machine operation.



GREEN+GENTLE CONCEPT

Franke Coffee Systems is particularly mindful of using resources sparingly. The Green+Gentle Concept epitomizes our continual efforts aimed at responsible and sustainable action and is a key aspect of our innovations. We combine ecological and economic aspects – resulting from our commitment to efficient production processes, sustainable materials management and the provision of energy-optimized product solutions. It is a promise we make today – for the generations of tomorrow!

FACTS & FIGURES

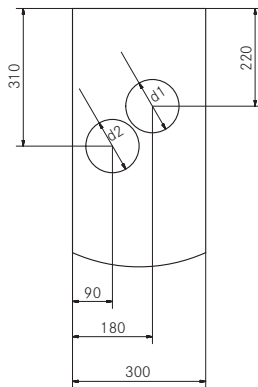
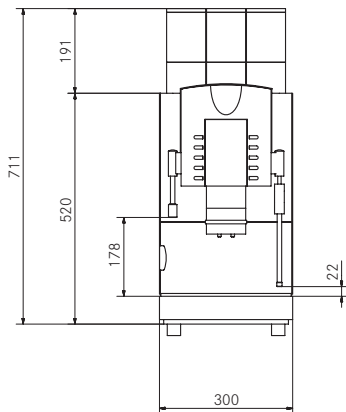
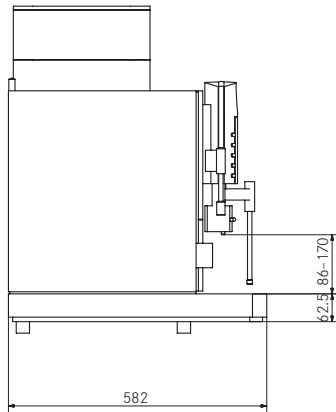

d1 = drilled hole for cables and lines 120 mm
d2 = drilled hole for coffee grounds chute 120 mm

FEATURES OF THE SPECTRA S, X & X-XL*

	SPECTRA S	SPECTRA X	SPECTRA X-XL
Espresso (cups/hour)	162 (232)	-	-
Cappuccino (cups/hour)	147 (216)	-	-
Café Creme (cups/hour)	115 (151)	Brewed coffee 294	Brewed coffee 369
Hot water (cups/hour)	239	193	290
Chocolate (cups/hour)	123	-	-
Energy loss in hot beverage dispensers per day (kWh)	2.13	2.93	3.47

* Number of cups/hour as per DIN 18873-2 (when dispensing nothing other than the respective product; the values in brackets were determined in double cup mode). Output data apply only for a minimum flow pressure of 2.6 bar.

MACHINE MODELS

MODEL	ELECTRICAL CONNECTION	POWER
Spectra S	200-240V 1LN PE 50/60 Hz 30 A 400V 3LN PE 50/60 Hz 16 A	4.4-5.85 kW 8.5 kW
Spectra X	400V 3LN PE 50/60 Hz 16 A	9.2 kW
Spectra X-XL	400V 3LN PE 50/60 Hz 16 A	9.3 kW

Standard color versions: Silver and Black Line

(Other connection variants on request)

ADD-ON UNITS

TYPES	ELECTRICAL CONNECTION	POWER
Refrigeration unit KE300 (12 liters)	200-240V 1LN PE 50/60 Hz 10 A	100 W
Refrigeration unit KE200 (4 liters)	220-240V 1LN PE 50/60 Hz 10 A	88 W
Chill & Cup (5 liters/80 cups)	230V 1LN PE 50/60 Hz 10 A	170 W
Base refrigeration unit UKE (5 liters)	230V 1LN PE 50/60 Hz 10 A	90 W
Refrigeration unit UT320 (12 liters)	230V 1LN PE 50/60 Hz 10 A	100 W
Cup warmer (120 cups)	230V 1LN PE 50/60 Hz 10 A	300 W

WATER CONNECTION

Supply line	Metal hose with union nut G3/8", L = 1.5 m
Water pressure	80 to 800 kPa (0.8 to 8.0 bar)
Water hardness	Max. 70 mg CaO/l water (7dH, 13 °fH)
Chlorine content	Max. 100 mg/l
Ideal pH value	7

DRAINAGE FOR DRIP TRAY

Waste-water hose	D = 16 mm, L = 2000 mm
	Spectra X-XL: D = 40 mm (Coffee grounds ejector)

Spectra X-XL

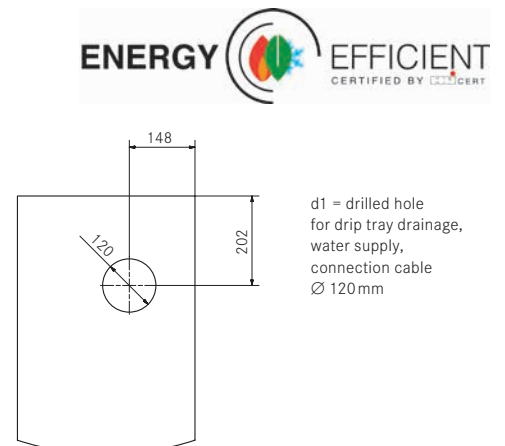
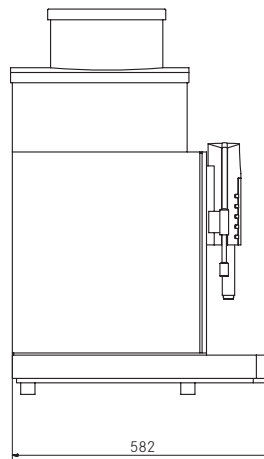
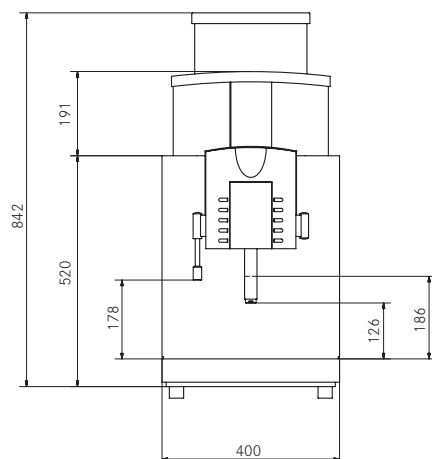

d1 = drilled hole for drip tray drainage, water supply, connection cable
Ø 120 mm



“I’M FUSSY WHEN
IT COMES TO COFFEE.
TO ME, QUALITY IS
THE RESULT OF ATTENTION
TO DETAIL.”

Franke Kaffeemaschinen AG
Franke Strasse 9
4663 Aarburg
Switzerland
Fon +41 62 787 36 07
Fax +41 62 787 30 10
www.franke.com

Franke Japan Inc.
Amflat, 12-35-12
Nihonbashi Ningyocho, Chuo,
Tokyo 103-0013
Japan
Fon +81 3 5642 5880
www.franke.com

Franke Coffee Systems GmbH
Franke Strasse 1
97947 Grünsfeld
Germany
Fon +49 9346 9278 0
Fax +49 9346 9278 100
www.franke.de

Franke Coffee Systems
Americas
800 Aviation Parkway
Smyrna, TN 37167
USA
Fon +1 615 462 4265
Fax +1 615 462 4400
www.franke.com

Franke Coffee Systems
UK Ltd
18 Handley Page Way,
Old Parkbury Lane,
St Albans,
Hertfordshire AL2 2DQ
England
Fon +44 1923 635700
Fax +44 1923 635701
www.franke.com

19'325'419/10.13/CH-EN Subject to dimensional, design and version changes.
visu/1 AG | Agentur für Identity und Kommunikation

